

# ingenico

## Move/2600

### User Guide



[www.ingenico.com](http://www.ingenico.com)

13-17 rue Pagès, 92150 Suresnes – France

Banks and Acquirers International Holding SAS / 814 767 216 RCS Nanterre



# Contents

<b>1. Introduction</b>	<b>4</b>
<b>2. Presentation</b>	<b>5</b>
<b>2.1 Content of the box</b>	<b>5</b>
<b>2.2 Overview on the Move/2600</b>	<b>6</b>
<b>2.3 Keyboard details and functionality</b>	<b>8</b>
<b>3. Use of the terminal</b>	<b>9</b>
<b>3.1 Switching off the terminal</b>	<b>9</b>
<b>3.2 Reading card</b>	<b>9</b>
<b>4. Installation</b>	<b>11</b>
<b>4.1 Recommendations</b>	<b>11</b>
<b>4.2 Terminal connections</b>	<b>11</b>
<b>4.2.1 USB</b>	<b>11</b>
<b>4.3 Opening trap door</b>	<b>12</b>
<b>4.4 SAMs &amp; SIMs</b>	<b>13</b>
<b>4.5 Cable connection</b>	<b>14</b>
<b>4.6 Battery</b>	<b>15</b>
<b>4.6.1 Main characteristics</b>	<b>15</b>
<b>4.6.2 Installing the battery</b>	<b>15</b>
<b>4.6.3 Charging the battery</b>	<b>16</b>
<b>4.6.4 Changing the battery</b>	<b>17</b>

<b>4.7</b>	<b>Paper roll</b> .....	<b>18</b>
<b>4.7.1</b>	<b>Main characteristics of Igenico roll</b> .....	<b>18</b>
<b>4.7.2</b>	<b>Installing paper roll</b> .....	<b>18</b>
<b>5.</b>	<b>Troubleshooting</b> .....	<b>20</b>

# 1. Introduction

We hope that you will be fully satisfied with your new terminal Move/2600. Please select by yourself in this documentation items related to your model.

Read this guide to understand and make the best use of your terminal. It presents you the necessary information about use, installation, maintenance, safety and security recommendations.



## WARRANTY / SECURITY

Use only the power supply included with the product to ensure best performance and safety. Maintenance should only be provided by Ingenico authorized technician. Failure to comply with these instructions will void the manufacturer's responsibility.



This symbol indicates an important Warning.



This symbol indicates a piece of advice.

## 2. Presentation

### 2.1 Content of the box

- Move/2600 terminal unit equipped with a paper roll



- A battery pack



- Power Supply Unit (PSU)



#### ADVICE

Keep the packaging. It must be re-used whenever the terminal is shipped.

## 2.2 Overview of the Move/2600

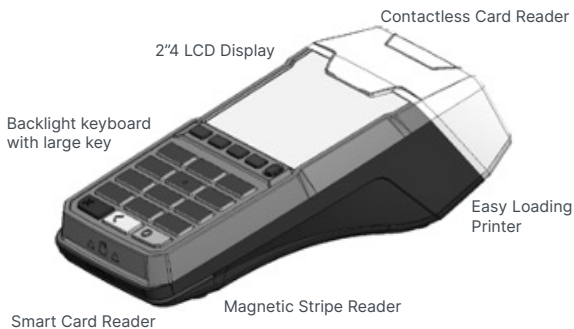

● **Compartment where are located:**

- The battery pack
- The SIM/SAM slots

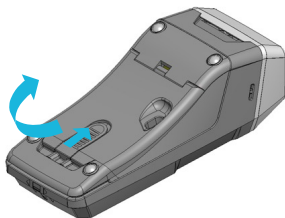
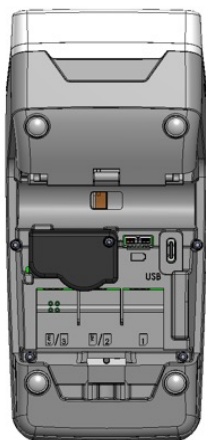

**Weight (without paper roll nor battery)**

254g

**Dimensions (L x w x h)**

167×76×56 mm

**Electrical mains network**

100 - 240VAC / 50-60 Hz or 50/60Hz - Class II equipment

**Connections on terminal**

USB-C connector for PSU

## 2.3 Keyboard details and functionality



Some keys can have other functions according to the applications that are in the terminal.







## 3. Use of the terminal



Before using the terminal, always check if the paper roll is present and if battery is connected. Without battery pack connected, printer and 4G connectivity won't be available.

### 3.1 Switching off the terminal

If the battery is empty and the terminal in use is removed from its base, the terminal automatically shuts off.

It may also be switch by pressing simultaneously  and  (yellow key) for one second.

In order to restart the terminal, press  on the keyboard.

### 3.2 Reading card

#### Magnetic stripe card

The card can be read either from left to right or from right to left, with the stripe on top of the terminal (stripe can be seen by user).

Use a regular movement to ensure a reliable card reading.



## Smart card

- insert the card horizontally with the chip facing upwards and leave in position throughout the transaction.

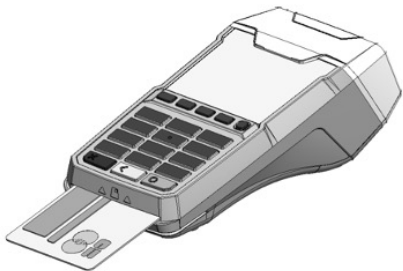

## Contactless (Cless)

- Bring the card firmly up to the active zone. Keep the card close to the reader during the transaction.
- The 4 virtual LEDs are displayed during the transaction.



The terminal behavior for the cardholder may depend on:

- The terminal environment
- Local usage (language,...)

## 4. Installation

### 4.1 Recommendations

#### Location of the Move/2600

Place the product on flat surface near an electric socket and according to the options close to an Ethernet socket. The terminal should be placed far from any very hot zones, protected from vibrations, dust, damp and electromagnetic radiation (computer screen, anti-theft barrier etc.).

#### Operating conditions

Ambient temperature	from +0°C to +50°C
Max relative humidity	85% at +40°C

#### Battery charging conditions

Ambient temperature	from +0°C to +45°C
---------------------	--------------------

#### Storage conditions

Ambient temperature	from -20°C to +55°C
Max relative humidity	85% at +55°C

## 4.2 Product connections

### 4.2.1 Terminal USB

A USB type C connector is available behind the battery door of Move/2600. This connector is used to connect PSU or USB type C to USB slave type A cable or USB type C to USB Host connector. This connector can also be used for SW loading.

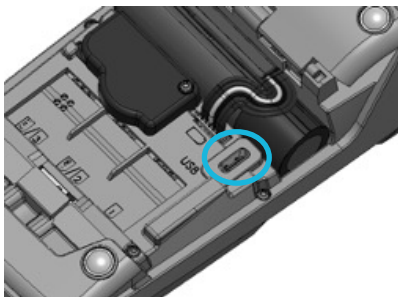

### 4.3 Opening trap door



#### CAUTION

Switch off the terminal before opening the trapdoor.

- Turn the terminal and unclip the trapdoor by pushing on the clip with as shown with the arrows on the picture

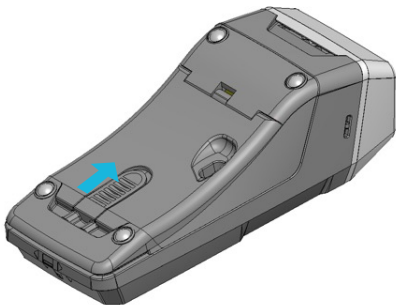

## 4.4 SAMs & SIMs

The connector modules security SAM/SIM is located inside the terminal, in a closed compartment. Please, switch off the Move/2600 prior inserting the SIM/SAM.

- SAMs and SIMs are identified by the engraved marks on the lower housing
- When introducing a SAM/SIM in its slot, be sure to put the cut corner as indicated on the engraved marks
- 3 factory options: 1SIM/2SAMs, 2SIMs/1SAM or 3 SAMs (always 3 SAMs when product doesn't embed 4G option)

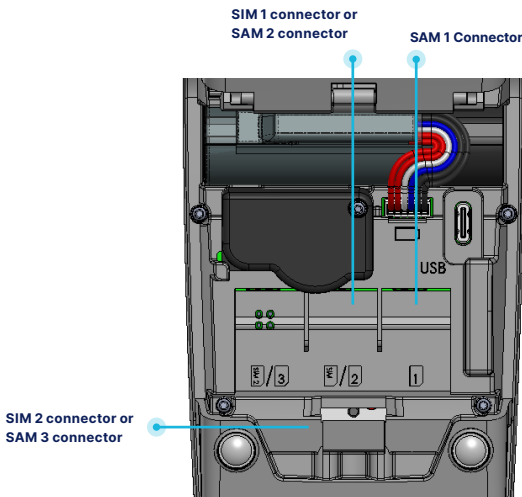

## 4.5 Cable connection

To use Magic Box connectivity, the use of cable is necessary and is included in your product box in option.

- Connect the cable and make it follow the cable way as shown on following picture. Take care to place it behind the plastic wall.

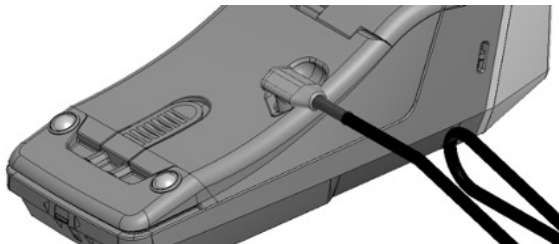

- Plug can be inserted in both directions.

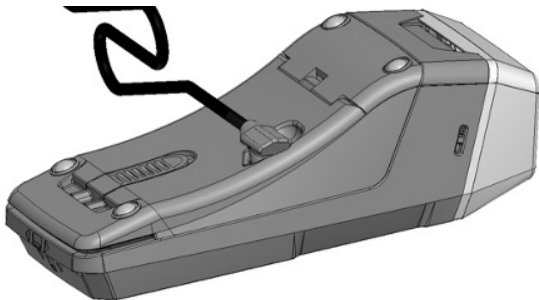

## 4.6 Battery

### 4.6.1 Mains characteristics

<b>Characteristics</b>	<b>Li-Ion 2250mAh</b>
<b>Charge (power supply 1A)</b>	50% of capacity in 1.5h (1A) Full capacity in 4h (1A)
<b>Battery life</b>	<ul style="list-style-type: none"><li>• 450 transactions in 4G with fully charged battery, printing and backlit activated</li><li>• Can remain powered ON up to 150 hours with connected 4G link and terminal in sleeping state starting with fully charged battery and without energy consumption related to backlit or radio link</li></ul>

### 4.6.2 Installing the battery



#### WARNING

Check that the terminal is not connected to the main electric network before installing or removing the battery.

- Turn your terminal and unclip the battery trapdoor by pushing on the button as shown on the picture
- Disengage the trapdoor
- Take the battery pack included in the box
- Locate the battery pack connector beside the battery compartment

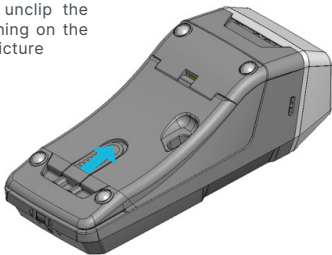

- Plug the battery pack connector according to the connector locating system and (as shown on picture). Verify that it locks.
- Place the battery pack in its compartment.
- Close the battery compartment trapdoor.

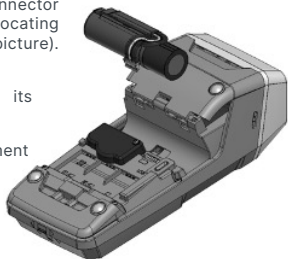

### 4.6.3 Charging the battery

- When does the battery need to be charged?
  - / **On initial start-up**, charge the battery for 16 hours under the environmental conditions stated above
  - / **When used with a terminal power supply**: connect the power supply to Move/2600 power connector
- How does the battery need to be charged?
  - / The environment in which the charge takes place influences battery lifetime and autonomy (number of transactions)

The optimal conditions are as follows:

  - / Charging away from any external heat source (radiator, sun, enclosed area...)
  - / The optimal temperature is between +15°C and +25°C
- How can the battery be charged?
 

**Using the terminal power supply**



  - / Connect the terminal power supply unit to the terminal USB type C connector located above the battery door
  - / Connect the power supply unit to the power supply mains networks
  - / **Check to see if the battery symbol is flashing or moving (=battery charging)**



## 4.6.4 Changing the battery



It is imperative to use the battery authorized by Ingenico. There is danger of explosion if battery used is not approved by Ingenico.

- Disconnect the power supply unit
- Turn product off by pressing simultaneously  (dot key) and  (yellow key) for one second.
- Remove the battery door (See chapter “Installation”).
- Lift the battery and remove it from its compartment.
- Carefully disconnect battery by pulling on connector. Avoid pulling wires to do not damage the battery.
- Connect and install the new battery by following the instructions in chapter “Installation”.
- In order to preserve the environment, dispose used battery in compliance with current country recycling legislation.

## 4.7 Paper roll

### 4.7.1 Main characteristics of Ingenico roll

Paper roll characteristics	Precisions
Color	White
Width	58 mm
Diameter	40 mm
Length	About 18 meters

The thermal paper can be deteriorated by poor storage conditions, so we recommend you to avoid:

- Storage in hot wet places (near air-conditioner, humidity higher than 85%)
- Exposure to sunlight or ultraviolet for long periods
- Contact with organic solvents (solvent type adhesive)
- Direct contact with materials containing plasticizers (PVC transparent folders or envelopes)
- Direct contact with "dialzo" papers
- Direct contact with water
- Rubbing or pressing the paper too strongly



#### WARNING

For best product performance, **only use heat sensitized paper approved by Ingenico.**

### 4.7.2 Installing paper roll



#### WARNING

Switch off the terminal prior to installing a paper roll. Use only paper approved by Ingenico. The use of non-approved paper is likely to damage the printer of your terminal.

- Open the paper compartment by lifting the catch located at the rear and under the terminal and pull the cover.

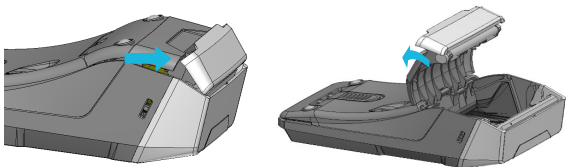

- Insert the paper roll in the compartment following the directions shown on the below picture.
- Pull the paper up to the top of the terminal.
- Maintain the paper and close the lid.
- Press simultaneously on both upper corners of the paper flap until it clips into position.

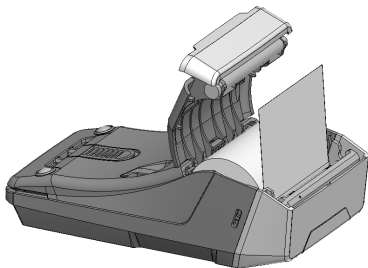

#### **ADVICE**

If you insert a new paper roll, tear off the first length (one complete turn to avoid printing on adhesive tape footprint).

## 5. Troubleshooting

### The terminal does not turn on

- Check the battery (is it discharged, is it connected?). A full discharged battery can take long charging time to recover.
- Connect terminal to terminal power supply or put it on powered base.

### Cards are not read

- Check that the magnetic card is swiped correctly (with magnetic band on terminal side).
- Swipe again the card with the magnetic stripe movement constant and rapid
- Verify that the magnetic strip is not damaged, grooved or cracked
- Make sure you have inserted correctly the smart card into the smart card reader and removed the card only after the transaction is performed.

### The ticket is not printed

- Check the presence and proper positioning of the paper roll. Possibly adjust the paper roll following the instructions in this manual (section 0 "Installing the paper roll")
- Check the type of paper used (thermal paper must be used)
- Verify thermal paper sensitive side.
- Check battery pack is correctly connected.



296302763AB

[www.ingenico.com](http://www.ingenico.com)

13-17 rue Pagès, 92150 Suresnes – France

Banks and Acquirers International Holding SAS / 814 767 216 RCS Nanterre