

ingenico

AXIUM DX8000-BASE-W2

User Guide

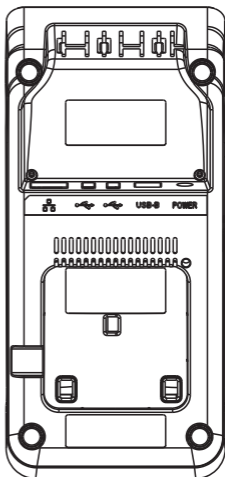
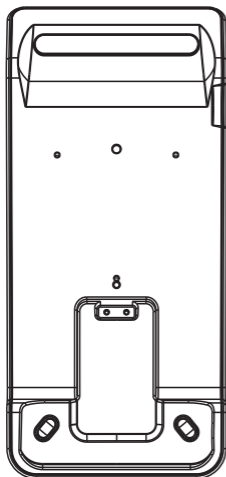

www.ingenico.com

13-17 rue Pagès, 92150 Suresnes – France

Banks and Acquirers International Holding, SAS / 814 767 216 RCS Nanterre



UYS01000651



Contents

Table of Contents	2
1. Product Introduction	3
1.1 What's in the Box – subject to ordered product configuration	3
1.2 Device Layout	3
1.3 Power Supply WARNING	4
1.4 Specifications	4
1.5 Environmental Conditions	4
2. Setup & Management with DX Terminal	5
2.1 Setup Base via DX Terminal Menu	5
2.2 Change Login Password	5
2.3 WAN and LAN Settings	6
2.4 Change SSID Pre-shared Keys (passwords)	6
2.5 Advanced Setting	7
2.6 Upgrade the Base Firmware – contact Ingenico for firmware updates	8
2.6.1 Use Software Manager to download “firmware.apk” to the DX8000 Terminal:	8
2.6.2 Log into the Base Manage app on the Terminal	8
2.7 Load or Save Base setting	9
2.7.1 Save current settings to a file	9
2.7.2 Load the base settings from a file	9
– see section 3.4 later in this guide	9
3. Setup & Management with Administrator Webpage	10
3.1 Access the Administrator application	10
3.2 Change SSID Pre-shared Keys (passwords)	10
3.3 Change Default Administrator Password	10
3.4 Restore Factory Settings	12
4. Base Operating Modes	13
4.1 Gateway / Router Mode – Default Operating Mode	13
4.2 Bridge Mode - (Also known as Access Point Mode)	13
4.3 WiFi Repeater Mode	14
5. Mount Base to Counter (Optional)	15
Appendix 1 – Frequently Asked Questions	16
Appendix 2 - Standards and Operating Information	17

1. Product Introduction

1.1 What's in the Box – subject to ordered product configuration

- DX Base Station
- Product instructions
- 12V/3.33A power supply
- Power cable

1.2 Device Layout

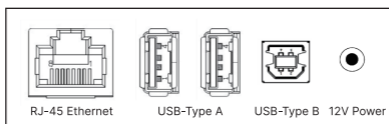
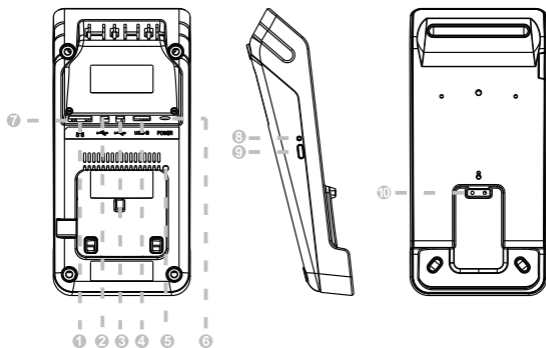

1) RJ45 Ethernet connector	2) USB - Type A	3) USB – Type A
4) USB – Type B	5) Factory Reset Button	6) Power connector – 12 VDC
7) Network Status LED	8) Pairing Status indicator	9) USB Pairing Button
10) DX8000 battery contacts		

1.3 Power Supply WARNING

- The power adapter provided is specially designed for Ingenico AXIUM DX8000-BASE-W2.
- Do not use any other power supply.
- Failure to use a certified power supply may damage your terminal and not be covered under the product warranty.

1.4 Specifications

Port	DC12V power connector 1XRJ45 Ethernet 10/100 network connector 2XUSB Type A HOST port supporting USB 2.0 1XUSB Type B DEVICE port supporting USB 2.0
Power	USB HOST output: 5.0VDC 0.5A Charger: Input-12V 3.3A / Output-5.0 VDC 2.0A Power Supply: Input 100-240VAC, 50 / 60HZ / Output 12VDC 3.33A
Size and Weight	Size: 193.8mm x 89mm x 38.6mm / 7.63in x 3.5in x 1.5in Net Weight: 0.20kg / 0.44 pounds Gross Weight: 0.70kg / 1.54 pounds

1.5 Environmental Conditions

Environmental conditions for transportation, storage and operation

Temperature	Operating	0°C~40°C / 32°F~104°F
	Storage and Delivery	-20°C~70°C / -4°F~158°F
Relative Humidity	Operating	10%~90%
	Storage and Delivery	5%~90% (at 40°C) / (104°F)
Atmospheric pressure		86kPa~106kPa ; 2000 meters above sea level

2. Setup & Management with DX Terminal

2.1 Setup Base via DX Terminal Menu

- Power on the base.
- Click “Settings” menu on DX8000 and then click “Base”.
- Click “Scanning Box” and scan the Data matrix barcode label on the back of base.
- On the Pop-up menu choose “Only use base Wi-Fi”.
- Wait for the “Successfully Connected” status.

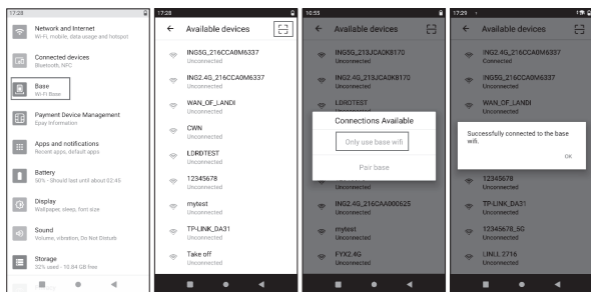

Settings

Available Devices

Base Connection

Confirm Connection

2.2 Change Login Password

Note: This is the password to access administrator settings only

- From the DX8000 settings menu, choose Base.
- Select the Management option.
- Go to the Set Logon password option at the bottom of screen.
- Enter the new password in the New Password box.
- Re-enter the password in the Confirm New Password box.
- Click Save and wait for the confirmation.



2.3 WAN and LAN Settings

- Tap on "Network" enter WAN Setting or LAN Setting menu.
- Choose WAN or LAN to view settings.

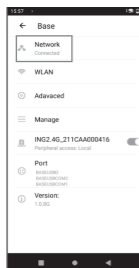

Base

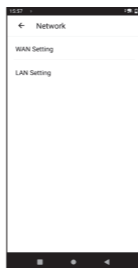

WAN or LAN

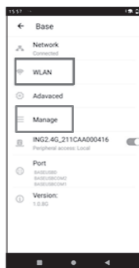

2.4 Change SSID Pre-shared Keys (passwords)

- Enter WLAN menu.
- Choose appropriate Wifi network - 2.4G WLAN or the 5G WLAN.
- Type new network password into the Pre-shared Key box at the bottom of the screen.
- Click save and then apply.
- Wait for confirmation.
- Click on the 5GHz WAN tab at the top of the screen.
- Repeat steps 3-4.

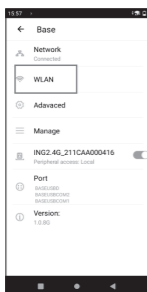

Base



WLAN

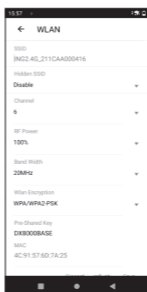

WLAN – 2.4 GHz

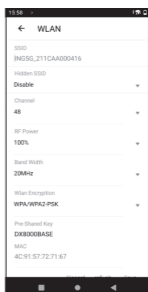

WLAN – 5.0 GHz

2.5 Advanced Setting

- Choose Advanced Settings Option
- Choose from one of the sub menus below
 - a) Advanced: Set the operating mode, DMZ and static DHCP of the base.
 - b) Operating Mode: Choose Mode required - Gateway Model is the default setting.
 - c) DMZ Setting: Leave set to disable by default.
 - d) Static / DHCP: Choose Static IP address if required. DHCP is the default.

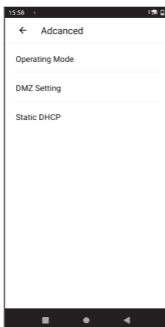

Advanced

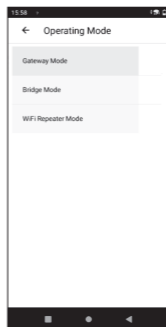

Operating Mode

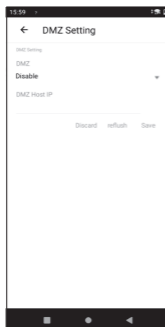

DMZ Setting

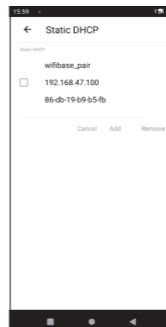

Static IP / DHCP

2.6 Upgrade the Base Firmware – contact Ingenico for firmware updates

2.6.1 Use Software Manager to download “firmware.apk” to the DX8000 Terminal:

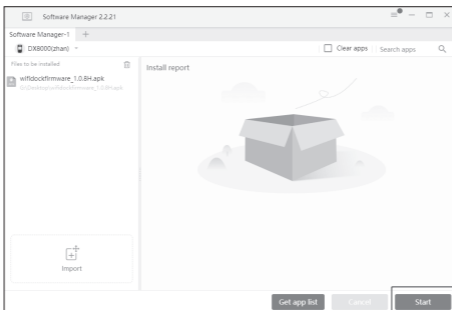

2.6.2 Log into the Base Manage app on the Terminal.

- Click on the Management tab.
- Click Upload to the right of Update Firmware.
- Select the firmware file downloaded previously.
- Verify that “Firmware upgrade” successful message is displayed.
- Check the firmware version of the base.



Upgrade Firmware

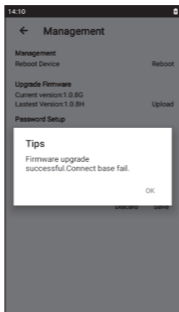

Confirmation

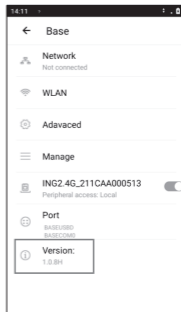

Validate Version

2.7 Load or Save Base setting

2.7.1 Save current settings to a file

- Click “Save”.
- Choose “Yes” when prompted to save settings.
- Verify that configuration saved successfully message is displayed.



Save settings

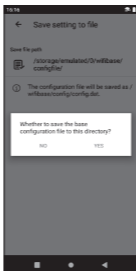

Verify

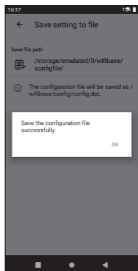

Confirm success

2.7.2 Load the base settings from a file

- Choose “Load” settings from file.
- Wait for updating to complete.
- Verify that Update Parameter is successful.

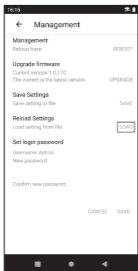

Load Settings

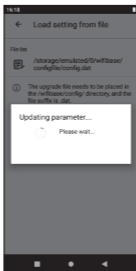

Updating



Confirmation

2.8 Restore Factory Settings

– see section 3.4 later in this guide

3. Setup & Management with Administrator Webpage

Note: Recommended only for administrator use

3.1 Access the Administrator application

- Use a computer to choose one of the two BASE default SSIDs.
 - a) Access the WiFi network settings on your computer
 - b) Example SSIDs are shown in the diagram to the right
 - c) 2.4 GHz or 5 GHz network will function correctly
- Use web browser to connect to the base default address.



<http://192.168.471>.

- Enter the default network password when prompted. It is printed on the label on the bottom of the Base.
- Browse the settings tabs - shown in more detail in the diagrams below
 - a) Status Page
 - b) WAN/LAN Page
 - c) WLAN
 - d) Operating Mode
 - e) Manage

3.2 Change SSID Pre-shared Keys (passwords)

- Select WAN Page – the 2.4 GHz network page will be displayed.
- Type new network password into the Pre-shared Key box.
- Click save and then apply.
- Wait for confirmation.
- Click on the 5GHz WAN tab at the top of the screen.
- Repeat steps 2-4.

3.3 Change Default Administrator Password

- Select Manage Page
- Type new password in both boxes
- Click save button
- Wait for confirmation

a) Status Page – provides Firmware version and status of the WAN and both the 2.4 and 5 GHz Wifi networks.

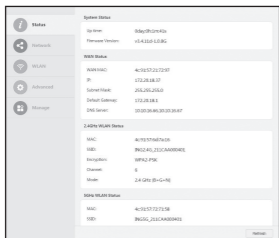

b) WAN/LAN page – provides settings for connection to networks within the location or beyond.

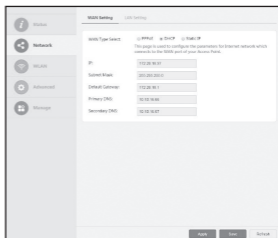

c) WLAN – Provides settings for 2.4 and 5 GHz Wifi networks and also a list of clients that have connected to either of the Wifi networks.

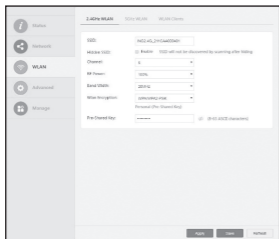

d) Operating Mode – Provides settings for supporting modes of operation. Gateway mode is the typical choice for most users.

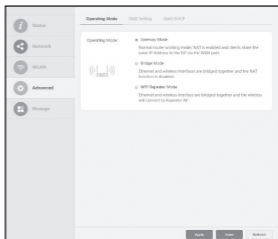

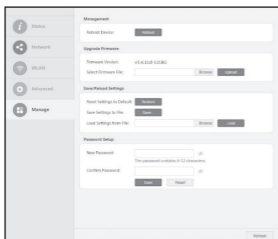

e) Manage Page - provides parameters to update firmware, save or load Base configuration and change the password.

NOTE: It is strongly recommended that all passwords are immediately changed from the default ones.

3.4 Restore Factory Settings

- Use paperclip or similar tool to press the RESET button for approximately 10 seconds.
- Base will revert to factory setting and automatically reboot.
- The location of the RESET button highlighted in the diagram.

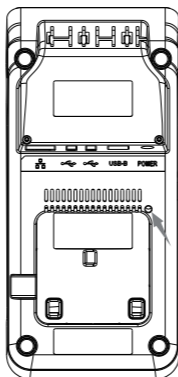

4. Base Operating Modes

4.1 Gateway / Router Mode – Default Operating Mode

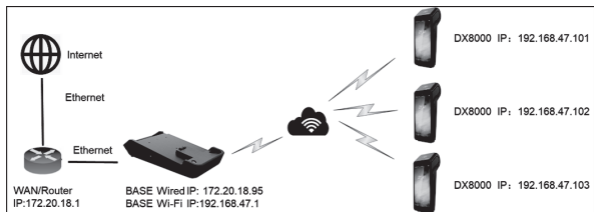

- Local router distributes a corporate IP address to the Base Station Ethernet port.
- Base distributes IP addresses to DX8000 devices via internal DHCP server.
- DX8000Base and devices are on private network segment (e.g. 192.168.47.X).
- Only the Base Station IP address is visible to and addressable by the network.
All of the device private IP addresses are masked from the network by NAT.

4.2 Bridge Mode - (Also known as Access Point Mode)

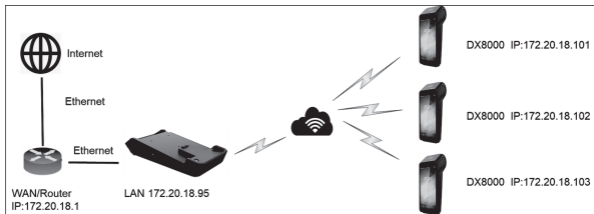

- Router distributes corporate IP network addresses to the bases and DX8000 devices.
- Base and devices are directly connected to local router and on the same network segment.
- Base DHCP server is turned off and NAT is not used.
- All device IP and MAC Addresses are visible to and addressable by the network.

4.3 WiFi Repeater Mode

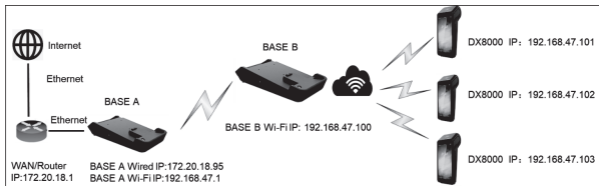

- Designed to expand wireless coverage, by connecting two bases together by Wifi.
- For example, DX8000 is too far away to connect Base A.
- Put Base B between Base A and DX8000 & Set Base B repeat the Base A.
- DX8000 can connect to internet via Base B.
- Does not operate with a Mesh network.

5. Mount Base to Counter (Optional)

Installation procedure:

- Position the space block on the table and install screws.
- Mount the Base fixing structure on the space block with three screws.
- Place base on the structure to lock it in position.
- Fasten the Base mounting structure on base with three screws.

NOTE: fasteners should be appropriate for counter material.

- Replace the battery cover of DX8000.
- Put DX8000 on the base to lock it.

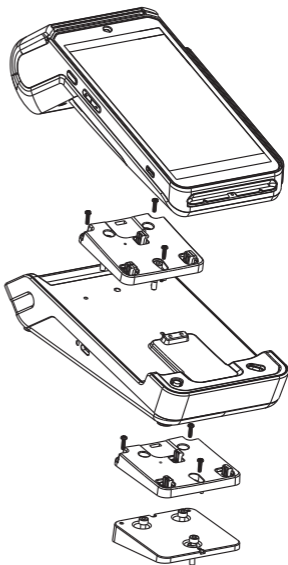
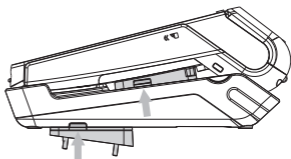

Appendix 1 – Frequently Asked Questions

Q1 : The base fails to connect DX8000.

- Issue DX8000 WLAN is not yet opened.
- Solution Open WLAN via the drop-down box of DX8000.

Q2 : Cannot access the Base web interface.

- Issue The DX8000 base password will not function correctly.
- Solution Input the correct password or restore factory setting to revert to the default password.

Q3 : The base is not connected to the DX8000, while the green indicator light flashes.

- Issue The two devices are too far away from each other that its connection fails.
- Solution Place the two devices in closer proximity.

Q4 : Mobile device cannot connect to 5GHz SSID, but the 2.4GHz one functions correctly.

- Issue Mobile device does not display the 5GHz SSID?
- Solution Verify that the mobile device supports 5GHz WiFi networks.

Q5 : It cannot be recognized when the base connects to PC/ECR by USB TYPE-B port.

- Cause It requires a CH340 driver to be installed on PC/ECR.
- Solution

For Windows, supported versions include 11/10/8.1/8/7/VISTA/XP/2000/98. And almost Windows 11/10 with Internet connected, the driver can be automatically installed once device connects to PC at the first time. Other Windows variants are also supported, include Windows Server (2022/2019/2016/2012/2008/2003), Windows Embedded and Windows IoT.

For macOS and Android, there are available drivers, but needs to be installed manually.

For Linux version is higher than 2.6.32 (or equal to 2.6.32), there is available driver just inside OS. But a few Linux versions which are customized (driver may be removed) need to install manually. And for Linux which version is lower than 2.6.32, it also needs to be installed manually.

More details please consult after-sales personnel.

Appendix 2 - Standards and Operating Information

RF exposure

The antenna of the product, under normal use condition is at least 20cm away from the body of the user. Warning statement to the user for keeping 20cm separation distance and the prohibition of operating to a person has been printed on the user manual. So, this product under normal use is located on electromagnetic far field between the human body.

CE Marking

- The CE marking indicates AXIUM DX8000-BASE-W2 complies with the requirements of European Directive 2014/53/EU on Radio Equipment for the protection of the health and safety of the user and any other person.
- The protection requirements with respect to electromagnetic compatibility. And complies with harmonized standards.

Operating Frequency Band (RF):

Network Type	TX Frequency	RX Frequency
802.11 b/g/n:	2412-2472MHz	2412-2472MHz
802.11a/n/ac:	5150-5250MHz 5250-5350MHz 5470-5725MHz 5725-5850MHz	5150-5250MHz 5250-5350MHz 5470-5725MHz 5725-5850MHz

Transmission power (max):

2.4GHz Wifi:	5.2/5.3/5.6GHz Wifi:	5.8GHz Wifi
15.87dBm (802.11b)	21.72dBm (802.11a)	13.90dBm (802.11a)
14.47dBm (802.11g)	19.57dBm (802.11n HT20)	13.76dBm (802.11n HT20)
16.46dBm (802.11n HT20)	19.95dBm (802.11n HT40)	13.70dBm (802.11n HT40)
16.29dBm (802.11n HT40)	19.96dBm (802.11ac VHT80)	13.70dBm (802.11ac VHT80)

Restrictions in the 5GHz band

According to Article 10(10) of Directive 2014/53/EU, the packaging shows that this terminal will be subject to some restrictions when placed on the market. In all EU member states, operation of 5150-5350MHz is restricted to indoor use only.



BE	BG	CZ	DK	DE	EE	IE	EL
ES	FR	HR	IT	CY	LV	LT	LU
HU	MT	NL	AT	PL	PT	RO	SI
SK	FI	SE	NO	IS	LI	CH	TR

Environment (WEEE, Batteries and packaging)

This product is labeled in accordance with European Directives 2012/19/EU concerning Waste Electrical and Electronic Equipment (WEEE) and 2013/56/EU concerning Batteries and Accumulators. Those provisions are requiring producers and manufacturers to become liable for take-back, treatment and recycling upon end of life of equipment and batteries.

THE PRODUCT



The crossed-out waste bin stuck on the product, or its accessories means that the product belongs to the family of electrical and electronic equipment, and waste batteries must not be thrown away but collected separately and recycles. Please contact your retailers for more detailed information about the compliance solution in place for disposing of your

old product and used batteries. Packaging waste must also be collected separately to assure a proper disposal and recycling. In this way you can participate in the re-use and upgrading of Electrical and Electronic Equipment Waste, which can have an effect on the environment and human health.

"INGENICO is a trademark of BANKS AND ACQUIRERS INTERNATIONAL HOLDING . This Document is Copyright © 2023 BANKS AND ACQUIRERS INTERNATIONAL HOLDING . BANKS AND ACQUIRERS INTERNATIONAL HOLDING retains full copyright ownership, rights and protection in all material contained in this document. The recipient can receive this document on the condition that he will keep the document confidential and will not use its contents in any form or by any means, except as agreed beforehand, without the prior written permission of BANKS AND ACQUIRERS INTERNATIONAL HOLDING. Moreover, nobody is authorized to place this document at the disposal of any third party without the prior written permission of BANKS AND ACQUIRERS INTERNATIONAL HOLDING. If such permission is granted, it will be subject to the condition that the recipient ensures that any other recipient of this document, or information contained therein, is held responsible to BANKS AND ACQUIRERS INTERNATIONAL HOLDING for the confidentiality of that information. Care has been taken to ensure that the content of this document is as accurate as possible. BANKS AND ACQUIRERS INTERNATIONAL HOLDING however declines any responsibility for inaccurate, incomplete or outdated information. The contents of this document may change from time to time without prior notice, and do not create, specify, modify or replace any new or prior contractual obligations agreed upon in writing between BANKS AND ACQUIRERS INTERNATIONAL HOLDING and the user. BANKS AND ACQUIRERS INTERNATIONAL HOLDING is not responsible for any use of this device, which would be non-consistent with the present document. All trademarks used in this document remain the property of their rightful owners"